

Date: _____

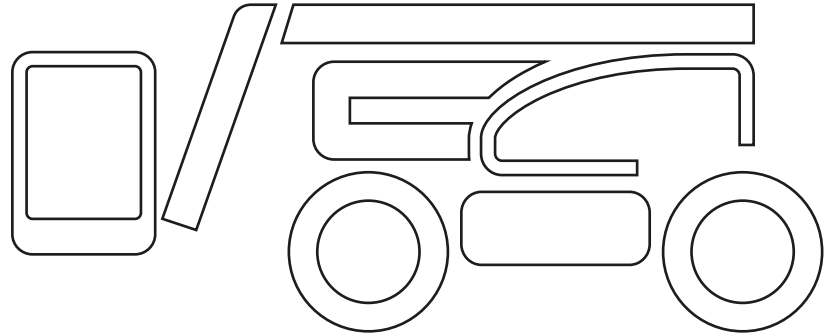

Colour me
nifty
Activity Book

Name: _____

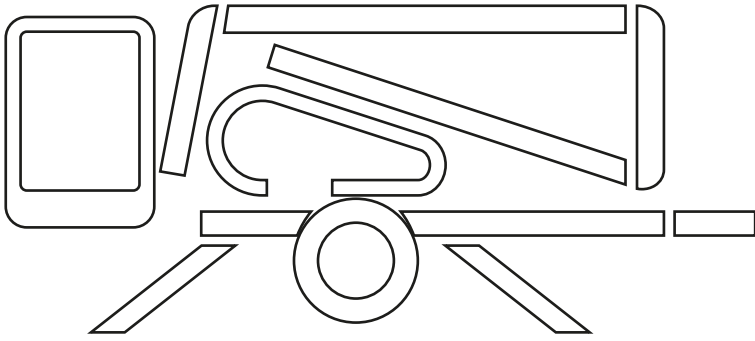
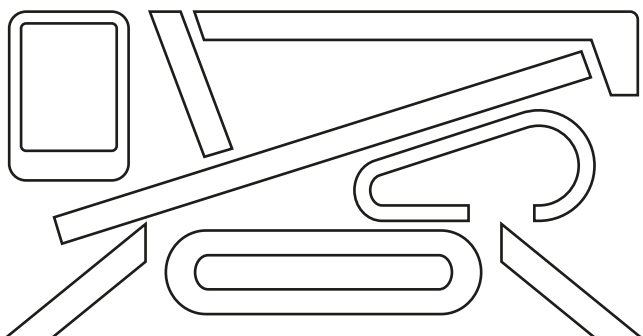
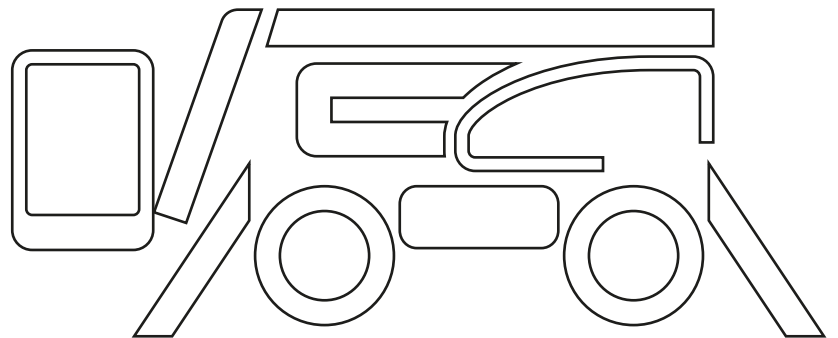

niftylift

Word Search

E	H	S	R	I	S	R	N	W	F	E	O	E	T	Z	A	P	U	D	W	I	W	G	N	I
X	V	H	R	S	E	F	W	P	P	V	D	W	P	U	Y	I	Y	B	T	O	J	S	I	J
Q	U	A	P	G	O	J	H	D	E	C	N	A	V	D	A	N	A	R	R	X	I	Z	F	U
W	B	O	A	M	H	A	Q	O	T	B	X	K	F	R	M	F	U	K	M	N	P	W	T	P
O	I	E	N	R	Y	R	M	H	C	U	M	Y	Q	A	B	H	I	R	T	X	P	M	Y	J
S	C	V	X	T	C	W	I	S	V	I	G	B	A	K	G	N	O	E	R	N	J	O	L	P
N	I	M	Y	A	L	L	E	L	E	C	T	R	I	C	G	F	L	P	Z	T	F	P	I	E
O	I	E	D	N	N	S	H	U	O	B	J	U	M	H	T	I	U	O	K	X	F	T	F	K
U	T	E	N	A	W	V	U	J	Y	D	D	C	E	A	G	C	C	Q	Z	B	Y	N	T	W
T	N	L	J	T	V	M	G	S	V	S	K	I	L	E	F	B	O	M	E	L	U	E	G	S
R	S	I	J	J	R	Q	K	Z	H	S	G	P	N	W	U	M	L	K	J	F	B	Z	S	N
E	Q	T	C	Y	R	E	O	Y	C	H	K	T	O	Q	X	F	F	X	R	U	D	D	Z	D
A	K	A	N	Y	A	Z	S	Y	T	R	Y	U	R	E	G	D	L	B	Q	Q	P	U	T	S
C	V	S	S	I	L	R	U	I	O	R	A	C	C	E	S	S	P	L	A	T	F	O	R	M
H	O	R	O	T	P	F	B	W	L	B	W	H	A	R	B	Z	T	E	Q	E	L	T	A	J
J	U	E	T	D	H	A	L	E	J	I	L	E	L	C	C	H	G	F	I	J	J	E	I	A
B	Z	V	E	C	P	A	U	P	Z	O	B	U	Z	F	O	W	C	F	B	H	Z	L	L	X
K	H	S	K	V	I	Q	W	L	E	Y	J	A	U	R	J	G	O	E	D	K	J	E	E	E
S	E	J	R	R	B	Q	P	L	Z	B	W	F	T	A	A	G	N	C	K	Z	C	M	R	H
Q	E	N	E	F	D	P	R	P	T	D	I	Q	Y	S	K	M	N	T	R	C	H	A	M	T
A	P	A	L	O	W	W	E	I	G	H	T	E	R	U	G	F	E	I	X	O	Z	T	O	X
J	O	G	K	E	V	T	F	Q	M	A	U	A	N	L	X	L	C	V	V	A	M	I	U	S
I	E	F	A	S	X	Z	R	Y	N	Q	W	X	I	E	I	P	T	E	P	T	G	C	N	F
W	F	U	O	T	M	L	U	S	G	O	F	W	U	J	R	W	E	C	G	O	M	S	T	O
P	M	I	N	N	O	V	A	T	I	V	E	Q	E	X	I	G	D	I	E	L	E	H	E	E
S	P	P	G	X	Z	W	L	E	Y	R	Y	K	Z	C	Y	M	Y	N	J	E	T	Q	D	H
T	D	K	W	D	Q	H	C	H	A	D	F	U	P	E	G	R	B	J	Q	U	R	U	X	
F	J	S	Y	V	C	K	B	H	R	E	G	G	I	R	T	U	O	V	C	N	D	S	H	O

- | | | | |
|--------------------|-------------|-----------|-----------------|
| accessplatform | connected | niftylift | stabiliser |
| advanced | effective | outreach | telematics |
| aerialworkplatform | innovative | outrigger | trailer-mounted |
| allelectric | intelligent | safe | versatile |
| bienergy | lowweight | siops | workingheight |

LOCAL
HEROES

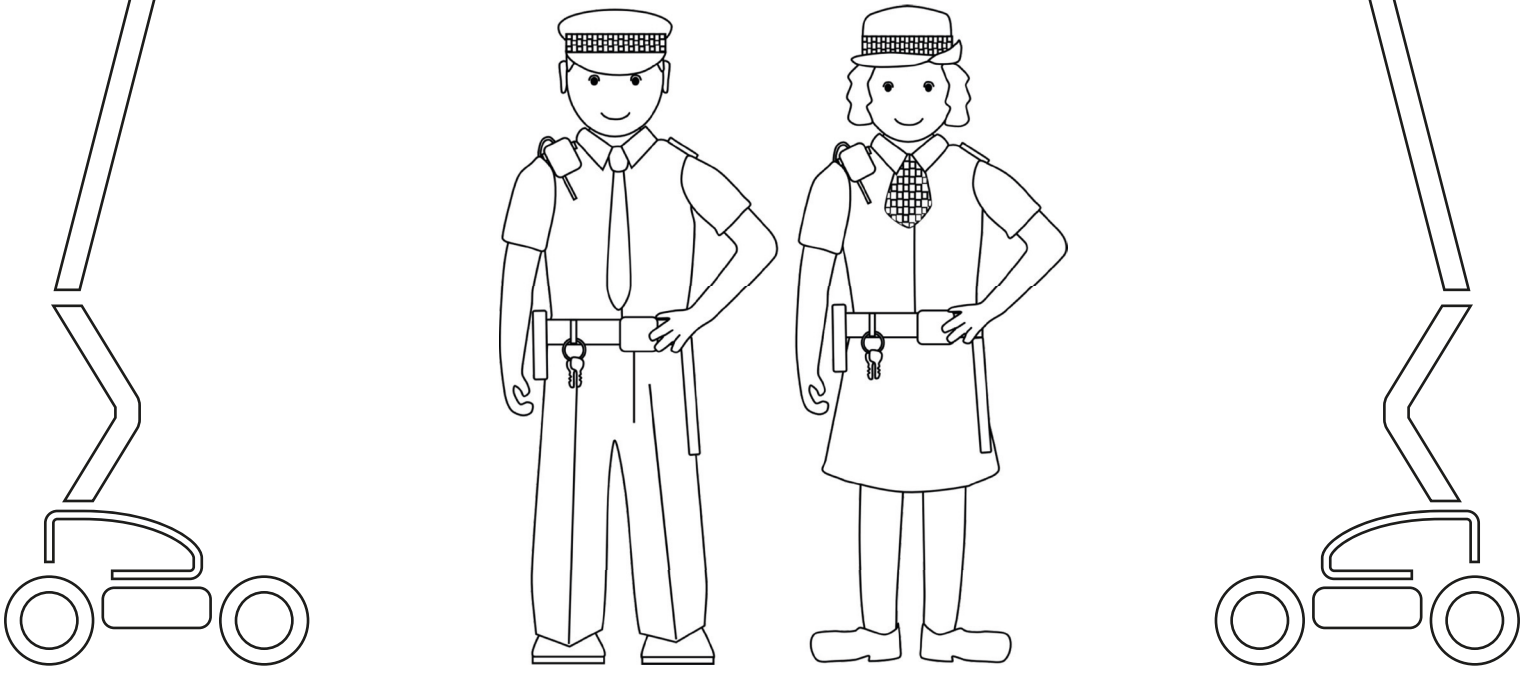

POLICE

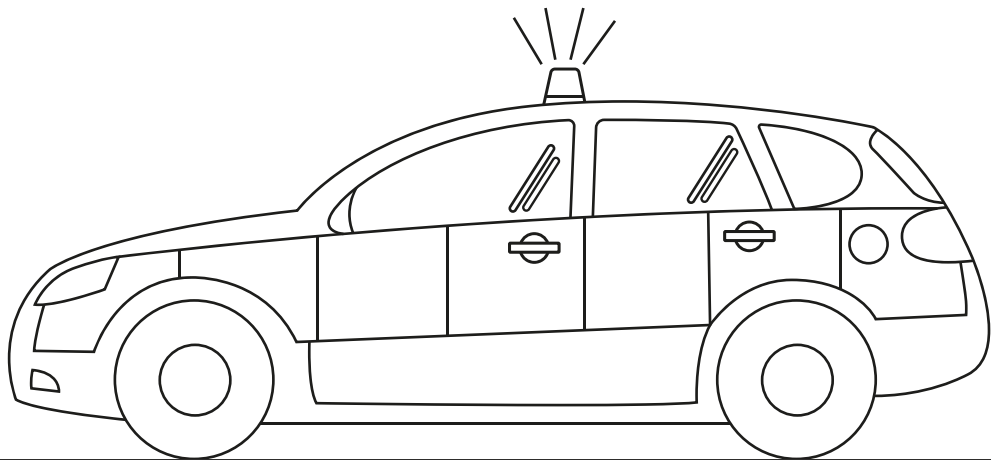

THANK YOU

Maze

START

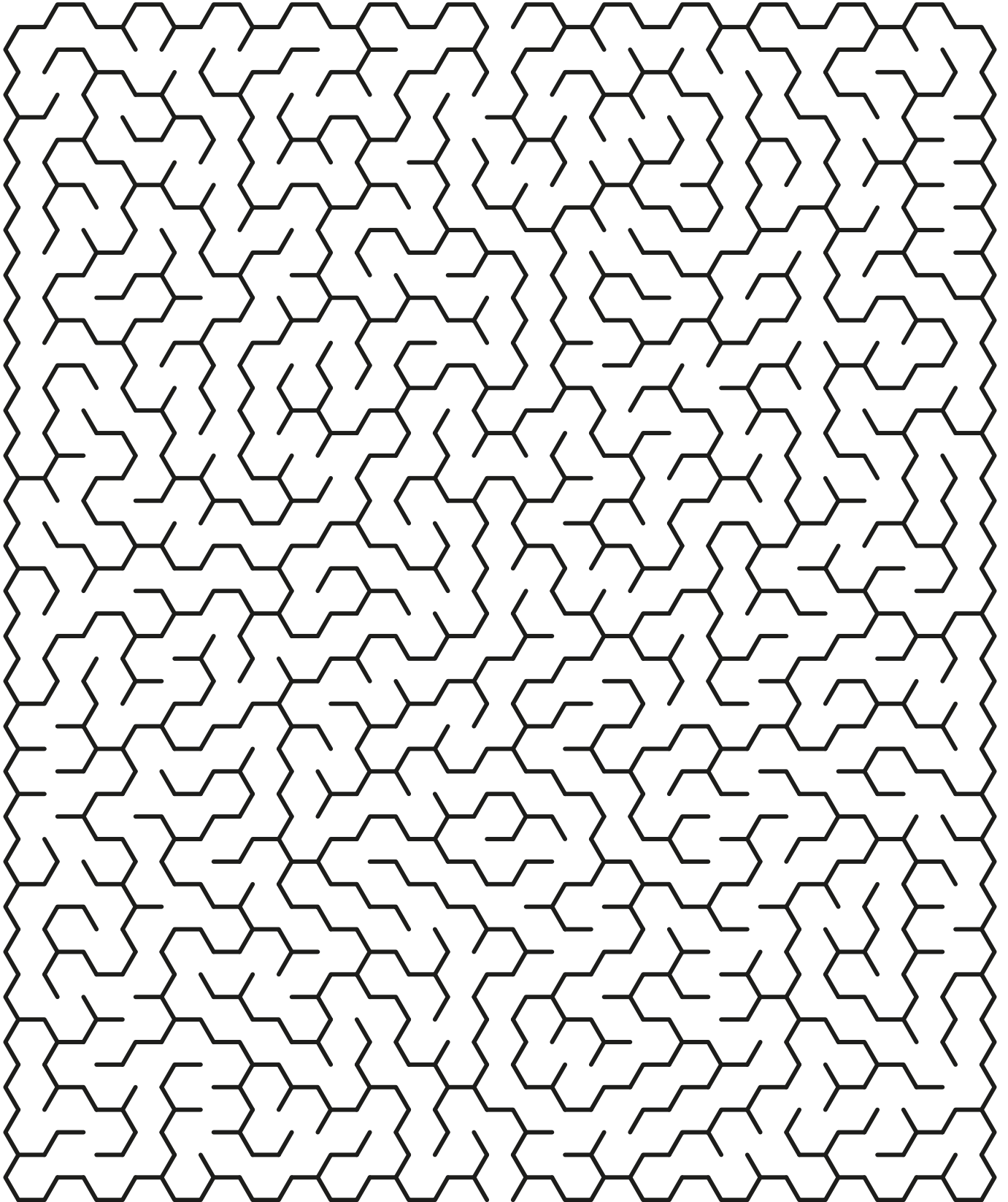

FINISH

Sudoku

Easy

7		1				9		4
3	4		8					
	6				4		1	2
			5				7	1
			7	9	1			
1	3				2			
5	7		9				4	
					5		8	3
8		6				2		9

Medium

4	9				3	5		
	8		1	5			9	
			6	4		8		
	5			6		3	4	
	6	2		3			1	
		3		9	6			
	2			1	7		8	
		4	8				3	9

Hard

	7	8		4				
3	6	4	7			8	5	
			5		8			
7					9		2	
6								4
	5		4					8
			2		5			
	1	7			6	9	4	5
				1		6	7	

Evil

	1				5	9		
		3		2	1		8	5
8	5		3					
				3				2
5	4						3	6
3				4				
					6		1	9
1	7		8	9		6		
		6	1				7	

LOCAL
HEROES

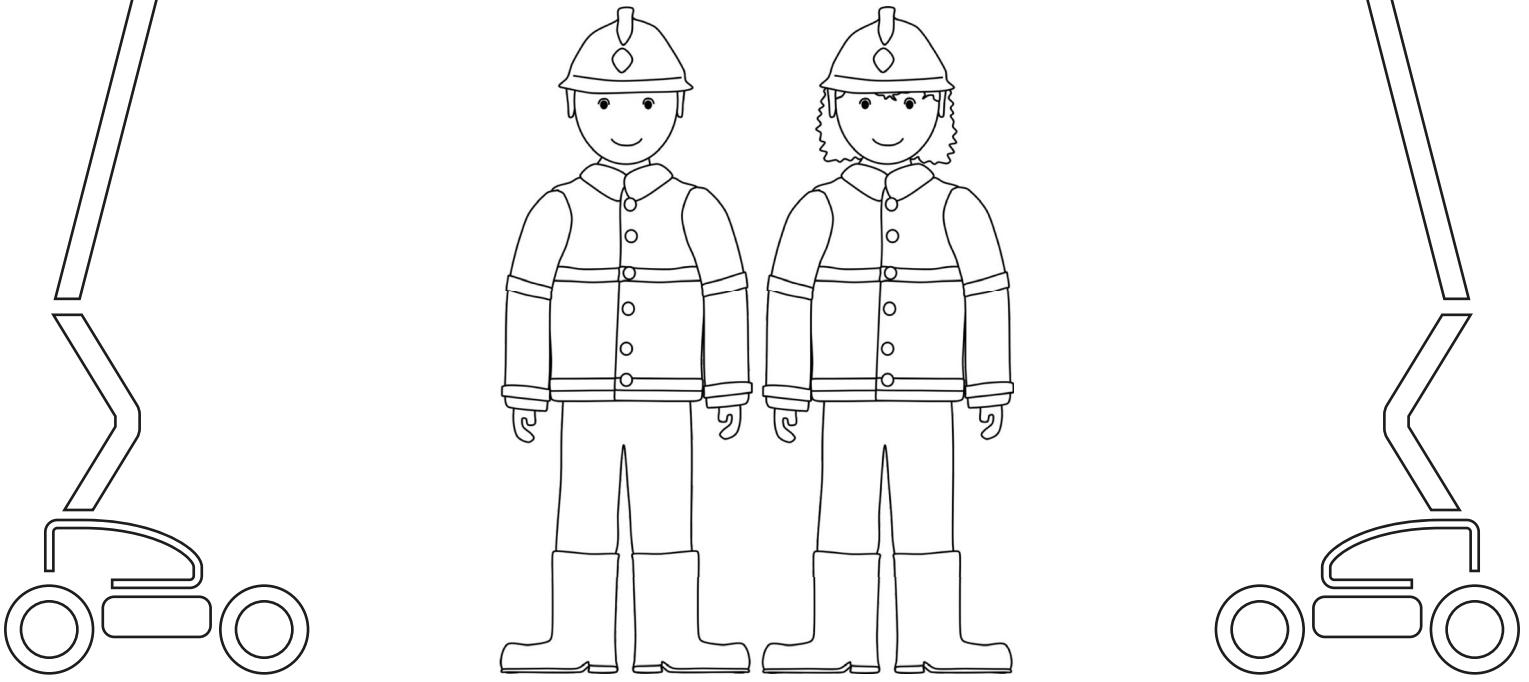

FIREFIGHTERS

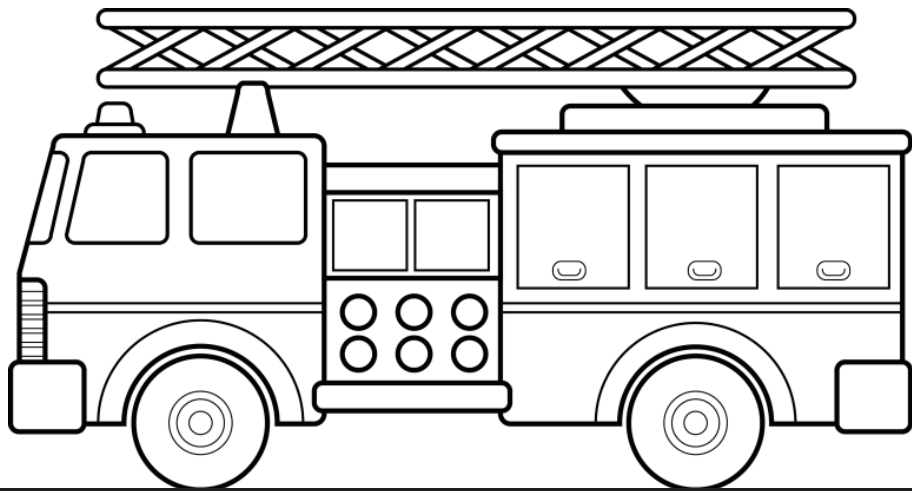

THANK YOU

Spot the Diff



Can you find all 10?



Answers

E	H	S	R	I	S	R	N	W	F	E	O	E	T	Z	A	P	U	D	W	I	W	G	N	I
X	V	H	R	S	E	F	W	P	P	V	D	W	P	U	Y	I	Y	B	T	O	J	S	I	J
Q	U	A	P	G	O	J	H	D	E	C	N	A	V	D	A	N	A	R	R	X	I	Z	F	U
W	B	O	A	M	H	A	Q	O	T	B	X	K	F	R	M	F	U	K	M	N	P	W	T	P
O	T	E	N	R	Y	R	M	H	C	U	M	Y	Q	A	B	H	I	R	T	X	P	M	Y	J
S	C	V	X	T	C	W	I	S	V	I	G	B	A	K	G	N	O	E	R	N	J	O	L	P
N	I	M	Y	A	L	L	E	L	E	C	T	R	I	C	G	F	L	P	Z	T	F	F	I	E
O	I	E	D	N	N	S	H	U	O	B	J	U	M	H	T	I	U	O	K	X	F	T	F	K
U	T	E	N	A	W	V	U	J	Y	D	D	C	E	A	G	C	C	Q	Z	B	Y	N	T	W
T	N	L	J	T	V	M	G	S	V	S	K	I	L	E	F	B	O	M	E	L	U	E	G	S
R	S	I	J	J	R	Q	K	Z	H	S	G	P	N	W	U	M	L	K	J	F	B	Z	S	N
E	Q	T	C	Y	R	E	O	Y	C	H	K	T	O	Q	X	F	F	X	R	U	D	D	Z	D
A	K	A	N	Y	A	Z	S	Y	T	R	Y	U	R	E	G	D	L	B	Q	Q	P	U	T	S
C	V	S	S	I	L	R	U	I	O	R	A	C	C	E	S	S	P	L	A	T	F	O	R	M
H	O	R	O	T	P	F	B	W	L	B	W	H	A	R	B	Z	T	E	Q	E	L	T	A	J
J	U	E	T	D	H	A	L	E	J	I	L	E	L	C	H	G	F	I	J	J	E	I	A	
B	Z	V	E	C	P	A	U	P	Z	O	B	U	Z	F	O	W	C	F	B	H	Z	L	L	X
K	H	S	K	V	I	Q	W	L	E	Y	J	A	U	R	J	G	O	E	D	K	J	E	E	E
S	E	J	R	R	B	Q	P	L	Z	B	W	F	T	A	A	G	N	C	K	Z	C	M	R	H
Q	E	N	E	F	D	P	R	P	T	D	I	Q	Y	S	K	M	N	T	R	C	H	A	M	T
A	P	A	L	O	W	W	E	I	G	H	T	E	R	U	G	F	E	I	X	O	Z	T	O	X
J	O	G	K	E	V	T	F	Q	M	A	U	A	N	L	X	L	C	V	V	A	M	I	U	S
I	E	F	A	S	X	Z	R	Y	N	Q	W	X	I	E	I	P	T	E	P	T	G	C	N	F
W	F	U	O	T	M	L	U	S	G	O	F	W	U	J	R	W	E	C	G	O	M	S	T	O
P	M	I	N	N	O	V	A	T	I	V	E	Q	E	X	G	D	I	E	L	E	H	E	E	
S	P	P	G	X	Z	W	L	E	Y	R	Y	K	Z	C	Y	M	Y	N	J	E	T	Q	D	H
T	D	K	W	D	D	Q	H	C	H	A	D	F	U	P	E	G	R	B	J	Q	U	R	U	X
F	J	S	Y	V	C	K	B	H	R	E	G	G	I	R	T	U	O	V	C	N	D	S	H	O

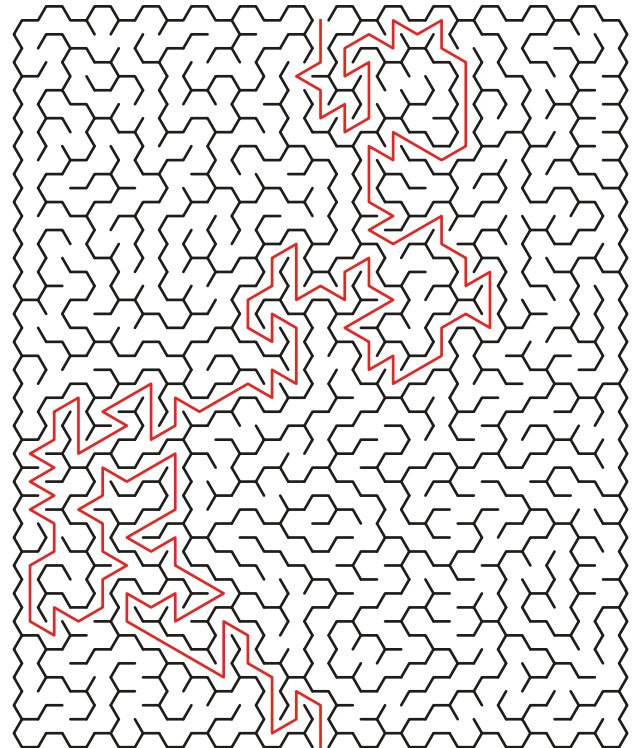

Easy

7	8	1	2	5	6	9	3	4
3	4	2	8	1	9	5	6	7
9	6	5	3	7	4	8	1	2
2	9	8	5	4	3	6	7	1
6	5	4	7	9	1	3	2	8
1	3	7	6	8	2	4	9	5
5	7	3	9	2	8	1	4	6
4	2	9	1	6	5	7	8	3
8	1	6	4	3	7	2	5	9

Medium

4	9	1	7	8	3	5	2	6
7	8	6	1	5	2	4	9	3
2	3	5	6	4	9	8	7	1
1	5	7	9	6	8	3	4	2
3	4	8	2	7	1	9	6	5
9	6	2	5	3	4	7	1	8
8	1	3	4	9	6	2	5	7
5	2	9	3	1	7	6	8	4
6	7	4	8	2	5	1	3	9

Hard

5	7	8	6	4	1	2	3	9
3	6	4	7	9	2	8	5	1
1	2	9	5	3	8	4	6	7
7	4	1	8	5	9	3	2	6
6	8	3	1	2	7	5	9	4
9	5	2	4	6	3	7	1	8
4	9	6	2	7	5	1	8	3
2	1	7	3	8	6	9	4	5
8	3	5	9	1	4	6	7	2



Evil

2	1	4	7	8	5	9	6	3
6	9	3	4	2	1	7	8	5
8	5	7	3	6	9	2	4	1
7	6	1	5	3	8	4	9	2
5	4	2	9	1	7	8	3	6
3	8	9	6	4	2	1	5	7
4	3	8	2	7	6	5	1	9
1	7	5	8	9	3	6	2	4
9	2	6	1	5	4	3	7	8

Please contact marketing@niftylift.com with any questions, comments or suggestions.